

robot coupe[®]



POWER MIXERS

NEW



RESTAURANTS - CATERERS - DELICATESSENS

COMPACT

MINI

▶ Mini MP

NEW

NEW

220 W



165 mm

MicroMix

240 W



160 mm

Mini MP 160 V.V.

270 W



190 mm

Mini MP 190 V.V.

290 W



240 mm

Mini MP 240 V.V.

For handling smaller quantities

2000 to 12500 rpm

▶ CMP

310 W



250 mm

CMP 250 V.V.

350 W



300 mm

CMP 300 V.V.

400 W



350 mm

CMP 350 V.V.

15 litres

30 litres

45 litres

2300 to 9600 rpm

▶ MP Ultra

STAINLESS STEEL MOTOR BASE

New, even more ergonomic handle design

440 W



350 mm

MP 350 Ultra

500 W



450 mm

MP 450 Ultra

750 W



550 mm

MP 550 Ultra

850 W



MP 600 Ultra

50 litres

100 litres

200 litres

300 litres

MP 350/MP 450 : 9500 rpm
MP 350 V.V./MP 450 V.V. : 1500 to 9000 rpm

9000 rpm

9500 rpm

▶ Special for emulsions

▶ For handling smaller quantities

▶ Special catering models Up to 45 litres

▶ Specially designed / commercial catering

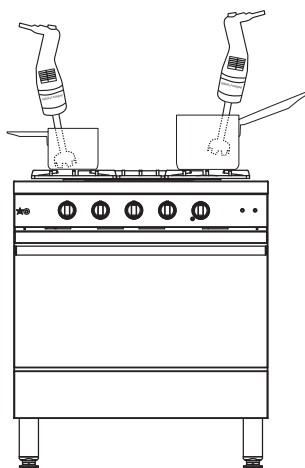

MicroMix Mini MP

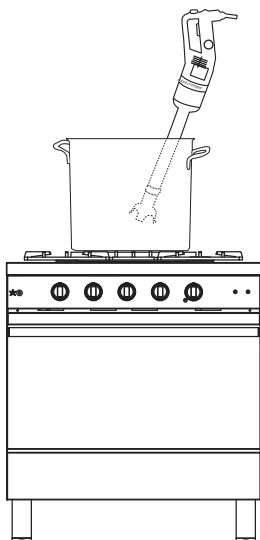

CMP

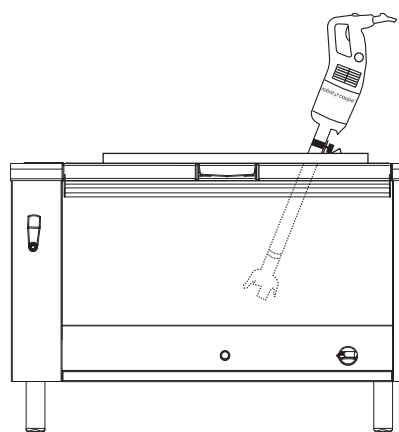

MP Ultra

COMBI

▶ Mini MP - CMP - MP Ultra - MP FW Ultra

STAINLESS STEEL MOTOR BASE

New, even more ergonomic handle design



MP 800 Turbo

400 litres

9500 rpm



Mini MP 190 Combi

Mini MP 240 Combi

For handling smaller quantities

Mixer : 2000 to 12500 rpm
Whisk : 350 to 1560 rpm



CMP 250 Combi

CMP 300 Combi

15 litres

30 litres

Mixer : 2300 to 9600 rpm
Whisk : 500 to 1800 rpm



MP 350 Combi Ultra

MP 450 Combi Ultra

50 litres

100 litres

Mixer : 1500 to 9000 rpm
Whisk : 250 to 1500 rpm



MP 450 FW Ultra

100 litres

250 to 1500 rpm



▶ MINI Range



▶ Mixer



▶ Emulsify

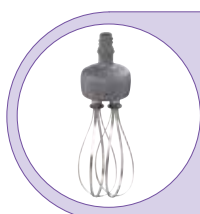

▶ Beat

FOR HANDLING SMALLER QUANTITIES

COMBI



Mini MP
160 V.V.

Mini MP
190 V.V.

Mini MP
240 V.V.

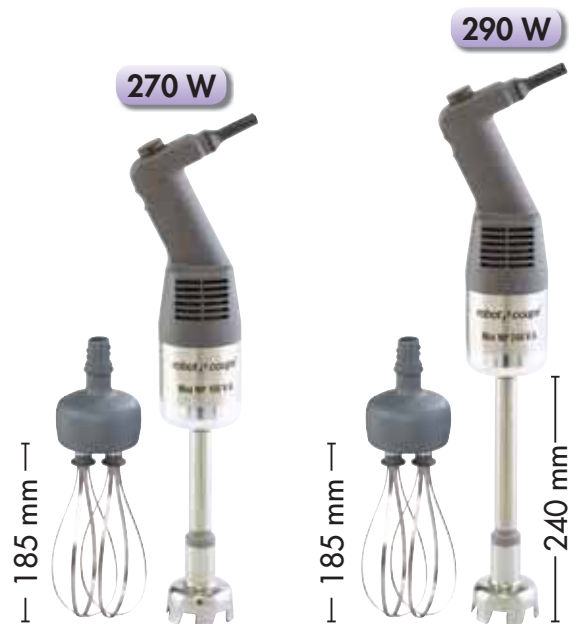

Mini MP
190 Combi

Mini MP
240 Combi

2000 to
12500 rpm

Mixer: 2000 to 12500 rpm
Whisk: 350 to 1560 rpm

▶ MINI Range



FOR HANDLING SMALLER QUANTITIES

ERGONOMIC



Shape of the handle specifically designed to ensure a **good grip** and manipulation of the Power Mixer, thus **reducing user fatigue**.

VARIABLE SPEED

- 2000 to 12500 rpm in mixer function
- 350 to 1500 rpm in whisk function



POWER



A powerful motor (220-270 W according to model) for an even longer lifespan!

HYGIENE



Detachable tube and blade assembly for perfect hygiene, with a patented system exclusive to Robot-Coupe. **Tube, bell and blade assembly all made from stainless steel** for a longer lifespan.

The Mini MP 190 V.V. and Mini MP 240 V.V. models have a detachable bell.

MULTIPURPOSE



Overmoulded stainless-steel blades ensuring perfect hygiene and ideal for making coulis, cream soups and sauces.



Detachable stainless-steel emulsifying disc for aerating hot and cold sauces and giving them a foamy consistency.



Mini MP Combi

STURDINESS

Whisk housing with all-metal interior for greater resilience.

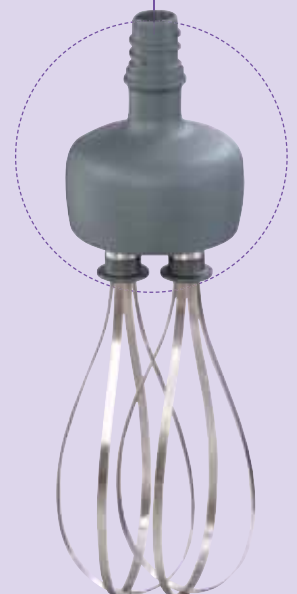

▶ COMPACT Range



▶ Mixer



▶ Beat

SPECIALLY DESIGNED FOR THE CATERING SECTOR

COMBI



2300 to 9600 rpm

Mixer: 2300 to 9600 rpm
Whisk: 500 to 1800 rpm

▶ COMPACT Range

SPECIAL CATERING MODELS UP TO 45 LITRES

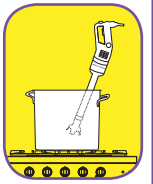

ERGONOMIC



Compact, lightweight appliance that is easy to handle

COMFORT



Variable speed function providing the greater flexibility required for sophisticated preparations.

NEW

POWER



More powerful motor: + 15% for even more efficient machine.

HYGIENE



Removable stainless steel blade and bell for easy cleaning and maintenance.

PERFORMANCE



The CMP Combi models (mixer+whisk) also boast a new 100% stainless-steel bell



Optimum blending quality giving the finished product a fine texture within a minimum of time.



CMP Combi

STURDINESS

- Whisk housing with all-metal interior for greater resilience.
- Overmoulded whisks ensuring perfect hygiene.

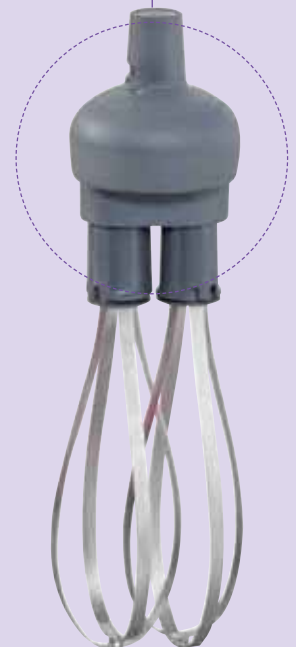

▶ LARGE Range



▶ Mixer

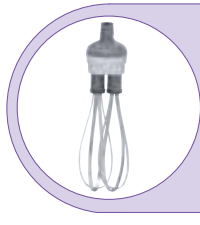

▶ Beat

SPECIALLY DESIGNED / COMMERCIAL CATERING

New, even more ergonomic handle design

				1000 W
440 W	500 W	750 W	850 W	
350 mm	450 mm	550 mm	600 mm	740 mm
MP 350 Ultra	MP 450 Ultra	MP 550 Ultra	MP 600 Ultra	MP 800 Turbo

COMBI

440 W	500 W	500 W
350 mm	280 mm	450 mm
MP 350 Combi Ultra	MP 450 Combi Ultra	MP 450 FW Ultra

MP 350/MP 450: 9500 rpm MP 350 V.V./MP 450 V.V.: 1500 to 9000 rpm	9000 rpm	9500 rpm	9500 rpm
--	----------	----------	----------

Mixer : 1500 to 9000 rpm Whisk : 250 to 1500 rpm	250 to 1500 rpm
---	-----------------

▶ LARGE Range

SPECIALY DESIGNED / COMMERCIAL CATERING

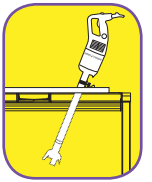

NEW

COMFORT



The V.V. and Combi models now have an **even more ergonomic variable speed button** for greater user comfort.

DURABILITY



Sturdy construction thanks to its **stainless steel motor base**.

HYGIENE

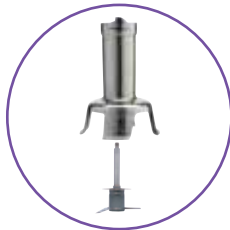

Removable stainless steel blade and bell for easy cleaning and maintenance.

PERFORMANCE



More powerful motor :
+ 20% for even more efficient machine.
Increased performance for **optimized mixing time**.



STAINLESS
STEEL

STAINLESS
STEEL

STAINLESS
STEEL

MP Combi

METAL GEAR BOX



• **Overmoulded whisks** ensuring perfect hygiene.



▶ PAN SUPPORTS MP/CMP

These 100% stainless-steel pan supports allow you to effortlessly tilt the mixer or simply leave it to its own devices. They can be totally dismantled, making them easy to clean and extremely practical to use.

Adjustable pan supports



Three pan supports available as optional extras.

They adapt to the size of the pan:

- Pan diameter 330-650 mm
- Pan diameter 500-1000 mm
- Pan diameter 850-1300 mm

Universal pan support



For any pans diameter.

▶ MIXING TOOL ATTACHMENT

Ergonomic handle

Rubber protection

- Variable speed from 150 to 510 rpm
- Total length of the tool : 690 mm
- Available as an optional extra with the Ultra Combi models.

Uses:

potato flakes, dehydrated base for soups etc...



▶ FOOD HYGIENE ADVICE CLEANING



Bell and blade removable for ease of cleaning

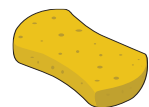

In line with HACCP advice, the cleaned bell and blade should be stored in a cold room after use

▶ LARGE Range

SPECIALLY DESIGNED / COMMERCIAL CATERING

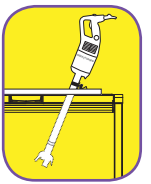

NEW

ERGONOMIC

- **Ergonomic handle** design for greater user comfort.



- **The speed variation button** on the V.V. and Combi models can easily be operated with one hand.



- **The lug on the motor housing** can serve as a rest and pivot on the rim of a pan, making the power mixer easier to handle.



- **New power cord winding system** for tidy storage and optimum lifespan.



DETACHABLE POWER CORD

- **New patented «Easy Plug» system** making it easier to replace the power cord during after-sales servicing.



EXCLUSIVE TECHNOLOGY



THE MAIN BENEFITS

- **Perfect hygiene:** Foot, knife, bell, and whisk fully removable - a Robot-Coupe exclusive.
- **Robust machine:** The design of the machines and the materials used in their construction guarantee a sturdy machine.
- **Large processing capacity:** Powerful motor for fast processing and an optimum quality end-product.
- **Easy maintenance:** All stainless steel tube, bell, knife and whisk.
- **Compact models:** Space saving and easy to use. 5 models to process small quantities.



PAN CAPACITY

Between 2 and 400 litres according to the model.



TARGET

Restaurants, Caterers, Delicatessens, Day Nurseries.



IN BRIEF

The performance in terms of hygiene, ease of use, multiple functions, longer life, and profitability make it the best choice on the market.



	Electrical data			Dimensions (in mm)				Weight (kg)	
	Variable speed (rpm)	Power (Watts)	Voltage* (Amp.)	A	B	C	D	net	gross
Micromix	1500 to 14000	220	230 V/50Hz - 1,1	68	430	61	165	1.07	1.44

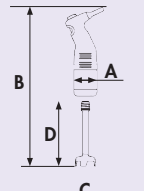

MINI RANGE	Electrical data			Dimensions (in mm)				Weight (kg)	
	Variable speed (rpm)	Power (Watts)	Voltage* (Amp.)	A	B	C	D	net	gross
Mini MP 160 V.V.	2000 to 12500	220	230 V/50Hz - 1.1	78	430	65	160	1.41	1.94
Mini MP 190 V.V.	2000 to 12500	250	230 V/50Hz - 1.3	78	470	65	190	1.5	1.97
Mini MP 240 V.V.	2000 to 12500	270	230 V/50Hz - 1.5	78	520	65	240	1.5	2.00

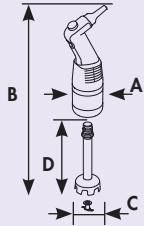

COMPACT RANGE	Electrical data			Dimensions (in mm)				Weight (kg)	
	Variable speed (rpm)	Power (Watts)	Voltage* (Amp.)	A	B	C	D	net	gross
CMP 250 V.V.	from 2300 to 9600	270	230 V/50 Hz 1.1	94	610	90	255	3.0	4.7
CMP 300 V.V.	from 2300 to 9600	300	230 V/50 Hz 1.2	94	660	90	305	3.1	4.8
CMP 350 V.V.	from 2300 to 9600	350	230 V/50 Hz 1.4	94	718	90	363	3.3	5.0

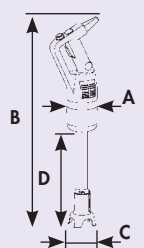

LARGE RANGE	Electrical data				Dimensions (in mm)						Weight (kg)	
	Speed (rpm)		Power (Watts)	Voltage* (Amp.)	A	B	C	D	E	F	net	gross
	Mixer	Mixer Variable speed										
MP 350 Ultra	9500		440	230 V/50 Hz 2.1	125	725	100	360			4.6	6.1
MP 350 V.V. Ultra		1500 to 9000	440	230 V/50 Hz 2.1	125	725	100	360	440	120	4.8	6.3
MP 450 Ultra	9500		500	230 V/50 Hz 2.3	125	825	100	460			4.9	6.4
MP 450 V.V. Ultra		1500 to 9000	500	230 V/50 Hz 2.3	125	825	100	460	440	120	5.0	6.4
MP 550 Ultra	9000		750	230 V/50 Hz 3.5	125	925	111	560			5.2	6.7
MP 600 Ultra	9500		850	230 V/50 Hz 3.4	124	970	110	580			5.7	7.6
MP 800 Turbo	9500		1000	230 V/50 Hz 4.5	125	1130	110	740			7.1	9

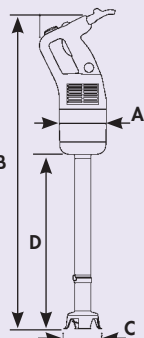

COMBI RANGE	Electrical data				Dimensions (in mm)						Weight (kg)	
	Mixer Variable speed (rpm)	Whisk Variable speed (rpm)	Power (Watts)	Voltage* (Amp.)	A	B	C	D	E	F	net	gross
Mini MP 190 Combi	2000 to 12500	350 to 1560	250	230 V/50 Hz 1.3	78	470	65	190	255	100	1.95	2.68
Mini MP 240 Combi	2000 to 12500	350 to 1560	270	230 V/50 Hz 1.5	78	520	65	240	255	100	1.98	2.70
CMP 250 Combi	2300 to 9600	500 to 1800	270	230 V/50 Hz 1.1	94	610	90	255	390	120	3.0	4.7
CMP 300 Combi	2300 to 9600	500 to 1800	300	230 V/50 Hz 1.4	94	660	90	305	390	120	3.1	4.8
MP 350 Combi Ultra	1500 to 9000	250 to 1500	440	230 V/50 Hz 2.1	125	775	100	410	440	120	5.9	8.3
MP 450 Combi Ultra	1500 to 9000	250 to 1500	500	230 V/50 Hz 2.3	125	875	100	510	440	120	6.1	8.5
MP 450 FW Ultra		250 to 1500	500	230 V/50 Hz 2.3	125	805	120	460	440	120	4.3	6.5

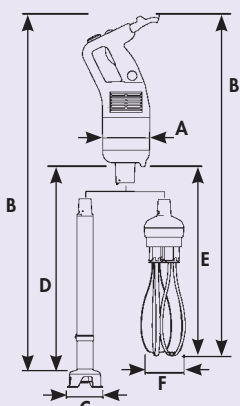

*Other voltages available.



HEAD OFFICE, FRENCH, EXPORT AND MARKETING DEPARTMENT:
Tel.: + 33 1 43 98 88 33 - Fax: + 33 1 43 74 36 26
email: international@robot-coupe.com

Robot Coupe Australia: Tel.: (02) 9478 0300 - Fax: (02) 9460 7972
New Zealand: Tel.: 0800 716161 - Fax: 0800 716162
email: orders@robotcoupe.com.au

Robot Coupe U.K. LTD: Tel.: 020 8232 1800 - Fax: 020 8568 4966
2, Fleming Way, Isleworth, Middlesex TW7 6EU
email: sales@robotcoupe.co.uk

Robot Coupe U.S.A.: Tel.: 1-800-824-1646 - Fax: 601-898-9134
email: info@robotcoupeusa.com - website: www.robotcoupeusa.com

www.robot-coupe.com

DISTRIBUTOR

STANDARDS:

Machines in compliance with :

- The following European directives and related national legislation: 2006/42/EC, 2006/95/EC, 2004/108/EC, 1935/2004/EC, 10/2011/EU, «RoHS» 2002/95/EC, «WEEE» 2002/96/EC.
- The following European harmonized standards and standards setting out health and safety rules: EN ISO 12100 - 2010, EN 60204-1 - 2006, EN 12853, EN 60529-2000: IP 55, IP 34.

